

Installation and service instructions

for contractors

VIESSMANN

Electronic temperature differential control unit

Vitosolic 100

Type SD1

For applicability, see the last page



VITOSOLIC 100

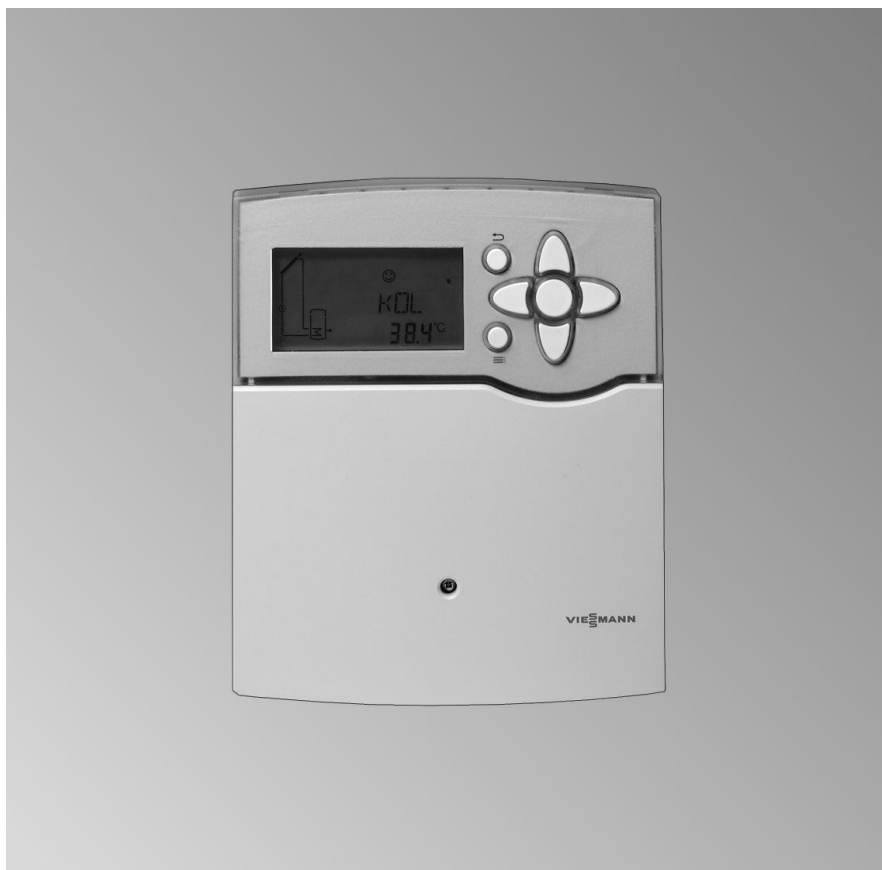

Safety instructions



Please follow these safety instructions closely to prevent accidents and material losses.

Safety instructions explained



Danger

This symbol warns against the risk of injury.



Please note

This symbol warns against the risk of material losses and environmental pollution.

Note

Details identified by the word "Note" contain additional information.

Target group

These instructions are exclusively designed for qualified personnel.

- Work on electrical equipment must only be carried out by a qualified electrician.
- The system must be commissioned by the system installer or a qualified person authorised by the installer.

Regulations

Observe the following when working on this system

- all legal instructions regarding the prevention of accidents,
- all legal instructions regarding environmental protection,
- the Code of Practice of relevant trade associations.
- all current safety regulations as defined by DIN, EN, DVGW, VDE and all locally applicable standards

Working on the system

- Isolate the system from the power supply and check that it is no longer 'live', e.g. by removing a separate fuse or by means of a main isolator.
- Safeguard the system against unauthorised reconnection.



Please note

Electronic modules can be damaged by electrostatic discharges.

Touch earthed objects, such as heating or water pipes, to discharge static loads.

Repair work



Please note

Repairing components that fulfil a safety function can compromise the safe operation of your heating system.

Replace faulty components only with original Viessmann spare parts.

Safety instructions (cont.)

Ancillary components, spare and wearing parts



Please note

Spare and wearing parts that have not been tested together with the heating system can compromise its function. Installing non-authorised components and non-approved modifications or conversions can compromise safety and may invalidate our warranty.

For replacements, use only original spare parts supplied or approved by Viessmann.

Index

Installation instructions

Preparing for installation

Installation information.....	6
System example 1.....	6
System example 2.....	11
System example 3.....	18
System example 4.....	24

Installation sequence

Fitting the solar control unit.....	35
Overview of electrical connections.....	36
Solar circuit pump.....	36
Pump/valve at output R2.....	38
High limit safety cut-out.....	39
Collector temperature sensor.....	40
Cylinder temperature sensor.....	41
Temperature sensor.....	41
Power supply.....	42

Service instructions

Commissioning

Switching the power ON.....	44
Navigation through the menu.....	44
Selecting the system scheme.....	44
Setting system parameters.....	45
Resetting system parameters.....	45
Carrying out a relay test.....	45

Service scans

Scanning temperatures and operating conditions.....	46
-----------------------------------------------------	----

Troubleshooting

Fault messages.....	47
Checking sensors.....	47
Changing the fuse.....	48

Function description

Parameter overview.....	49
System scheme.....	51
Collector limit temperature.....	62
Collector cooling function.....	62
Minimum collector temperature limit.....	62

Index (cont.)

Frost protection function.....	63
Reverse cooling function.....	63
Interval function.....	63
Heat statement.....	64
Speed control.....	64
Parts list	66
Specification	67
Appendix	68
Certificates	
Declaration of conformity.....	69
Keyword index	70

Installation information



Danger

Subject to system configuration, DHW temperatures above 60 °C can occur. DHW with temperatures in excess of 60 °C can result in scalding.

To limit the temperature to 60 °C, install mixing equipment, e.g. a thermostatically controlled mixing valve (accessory). Install a mixer tap as anti-scalding device at the draw-off point.

System example 1

DHW heating with dual-mode DHW cylinder

Main components

- Viessmann solar collectors
- DHW cylinders Vitocell 100-B or Vitocell 300-B
- Vitosolic 100, type SD1
- Solar-Divicon
- Wall mounted oil/gas boiler or oil/gas boiler

Function description

DHW heating with solar energy

Solar circuit pump R1 (33) starts and DHW cylinder (10) is heated up if the temperature differential between collector temperature sensor S1 (31) and cylinder temperature sensor S2 (11) exceeds the starting temperature differential DT E.

Solar circuit pump R1 (33) is stopped in accordance with the following criteria:

- The actual temperature falls below the shutdown temperature differential DT A.
- Exceeding the electronic temperature limit (max. 90°C) of control unit (36)
- Reaching the temperature selected at high limit safety cut-out (12) (if installed)

Auxiliary function for DHW heating

The requirements for the auxiliary function are achieved through circulation pump R2 (15).

Suppression of DHW cylinder reheating by the boiler

Coding address "67" in boiler control unit (2) defaults a third set DHW temperature (setting range 10 to 95 °C). This value must be below the first set DHW temperature. DHW cylinder (10) will only be heated by boiler (1) (solar circuit pump R1 (33) runs) if this set value cannot be achieved by the solar thermal system.

DHW heating without solar energy

The upper section of DHW cylinder (10) is heated by boiler (1). The cylinder thermostat with cylinder temperature sensor (3) of boiler control unit (2) regulates cylinder heating.

System example 1 (cont.)

Required settings on the solar control unit

Parameters	Delivered condition	Description	Setting
ANL	1	Without auxiliary function for DHW heating	1
		With auxiliary function for DHW heating (see page 56)	4
DT E	8 K	Start temperature differential for solar circuit pump at R1	
DT A	4 K	Stop temperature differential for solar circuit pump at R1	
S SL	60 °C	Set cylinder temperature (see page 53)	

For further functions, see chapter "Functions" from page 49.

Note

"DT E" can be set at least 0.5 K higher than "DT A".

"DT A" can be set up to 0.5 K below "DT E".

Information regarding speed control of the solar circuit pump

Observe chapter "Speed control" (see page 64).

System example 1 (cont.)

Hydraulic installation diagram

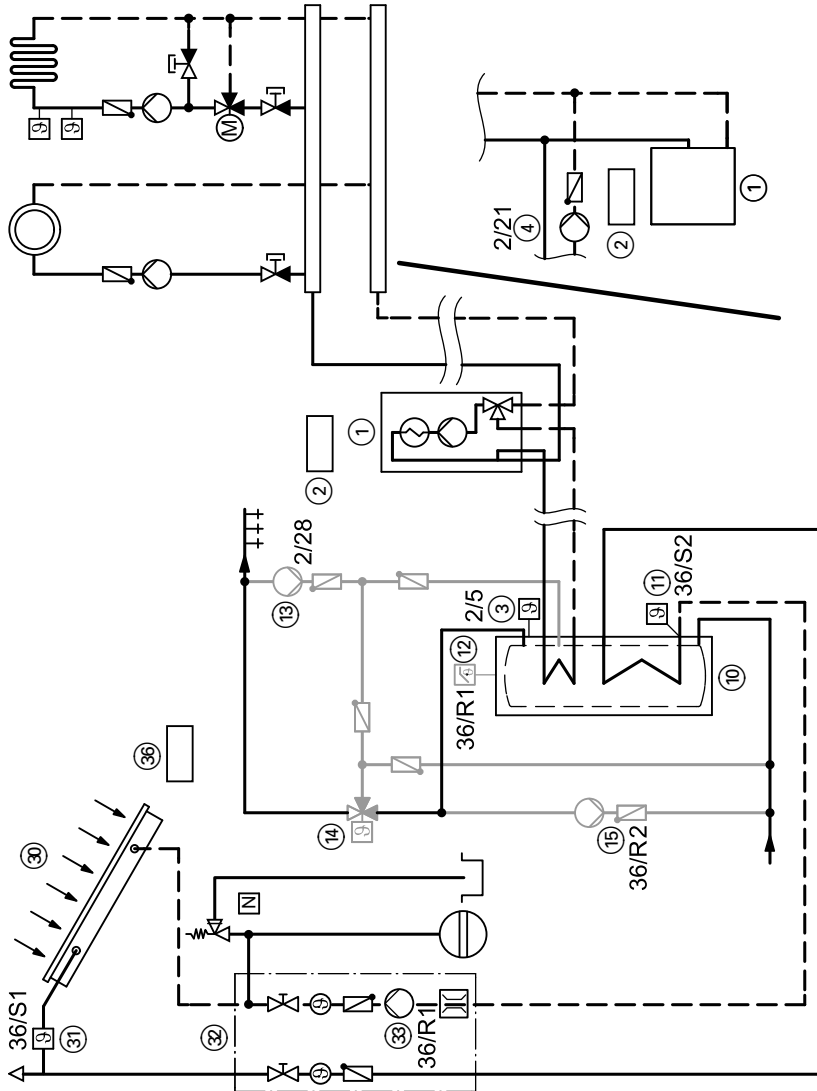

System example 1 (cont.)**Equipment required**

Pos.	Description
①	Oil/gas boiler or wall mounted oil/gas boiler with
②	Boiler and heating circuit control unit
③	Cylinder temperature sensor
④	Circulation pump for cylinder heating (integrated for wall mounted oil/gas boiler)
⑩	Dual-mode DHW cylinder
⑪	Cylinder temperature sensor S2
⑫	High limit safety cut-out (accessory)
⑬	DHW circulation pump (on site) (internal/external extension may be required for connecting a wall mounted oil/gas boiler)
⑭	Thermostatic mixing valve (accessory)
⑮	Circulation pump R2 (anti-stratification) (on site)
⑳	Solar collectors
㉑	Collector temperature sensor S1
㉒	Solar-Divicon (accessory) with
㉓	Solar circuit pump R1
㉔	Vitosolic 100, type SD1
㉕	Junction box (on site)
㉖	ON/OFF switch (on site)

System example 1 (cont.)

Electrical installation diagram

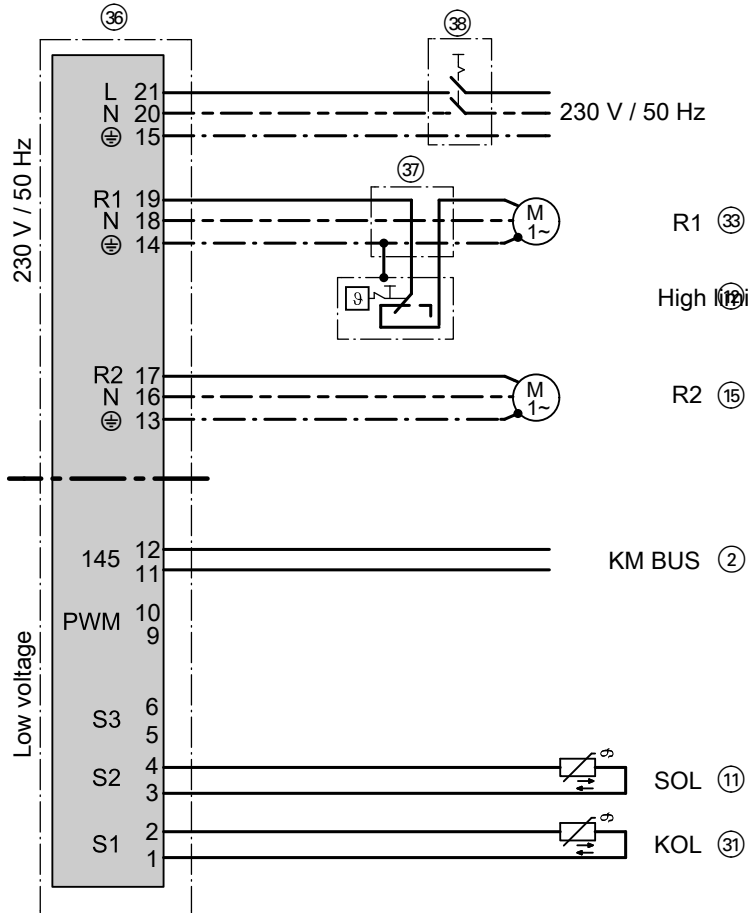

System example 2

Vitodens – DHW heating and central heating backup with a multi-mode heating water buffer cylinder

Main components

- Viessmann solar collectors
- Vitocell 340-M or Vitocell 360-M multi-mode heating water buffer cylinder with integral DHW heating, with or without stratification system
- Vitosolic 100, type SD1
- Solar-Divicon
- Wall mounted gas boiler from the year of manufacture 2008
 - Vitodens 200-W, type WB2B
 - Vitodens 300-W, type WB3C

Function description

DHW heating with solar energy

Solar circuit pump R1 (33) starts and heating water buffer cylinder (10) is heated up if the temperature differential between collector temperature sensor S1 (31) and cylinder temperature sensor S2 (11) exceeds the starting temperature differential DT E.

Solar circuit pump R1 (33) is stopped in accordance with the following criteria:

- The actual temperature falls below the shutdown temperature differential DT A.
 - Exceeding the electronic temperature limit (max. 90°C) of control unit (36)
 - Reaching the temperature selected at high limit safety cut-out (12) (if installed)
- Entire heating water buffer cylinder (10) is heated by the solar thermal system if the insolation is adequate.

The upper part of heating water buffer cylinder (10) will only be reheated by boiler (1) if the actual water temperature falls below the set temperature selected at boiler control unit (2).

If the solar energy is inadequate to cover the entire heating demand, the DHW in the lower part of heating water buffer cylinder (10) will be preheated by solar energy. The DHW in the upper part of the cylinder is heated to the required temperature by boiler (1).

The burner is started and three-way diverter valve (46) is switched to position "AB-A" via cylinder temperature sensor (16) of the boiler control unit. When the set DHW temperature has been reached, the burner is stopped and three-way diverter valve (46) is switched to position "AB-B".

Suppression of DHW cylinder reheating by the boiler

Coding address "67" in boiler control unit (2) defaults a third set DHW temperature (setting range 10 to 95 °C). This value must be below the first set DHW temperature. Heating water buffer cylinder (10) is only heated by boiler (1) (solar circuit pump R1 (33) runs) if this set value cannot be achieved by the solar thermal system.

System example 2 (cont.)

DHW heating without solar energy

The upper area of heating water buffer cylinder (10) is heated by boiler (1). The integral instantaneous water heater/standby section is heated by the surrounding buffer cylinder water. The cylinder thermostat with cylinder temperature sensor (16) of boiler control unit (2) controls three-way diverter valve (46).

Central heating with solar energy

The system provides central heating if the temperature at sensor (15) is adequate.

Central heating without solar energy

If the temperature at sensor (15) is inadequate, the burner and circulation pump in the Vitodens are started. The area between HV2/HR1 and HR2 in heating water buffer cylinder (10) is heated up to the set temperature for the heating circuits in weather-compensated mode. When this set temperature is exceeded, the burner and, after a delay, the circulation pump in the Vitodens are stopped.

Required settings on the solar control unit

Parameters	Delivered condition	Description	Setting
ANL	1	Without auxiliary function for DHW heating	1
DT E	8 K	Start temperature differential for solar circuit pump at R1	
DT A	4 K	Stop temperature differential for solar circuit pump at R1	
S SL	60 °C	Set cylinder temperature (see page 53)	

For further functions, see chapter "Functions" from page 49.

Note

"DT E" can be set at least 0.5 K higher than "DT A".

"DT A" can be set up to 0.5 K below "DT E".

Information regarding speed control of the solar circuit pump

Observe chapter "Speed control" (see page 64).

System example 2 (cont.)**Codes required at the boiler and heating circuit control unit**

Code	Function
51:1	The internal circulation pump is only switched on when the burner has been started (time delay off)
53:3	System without DHW circulation pump: Three-way diverter valve (46) is connected to output (28) of inter- nal extension H1 or H2
5b:1	Internal diverter valve without function (DHW cylinder connected downstream of the low loss header)

System example 2 (cont.)

Hydraulic installation diagram

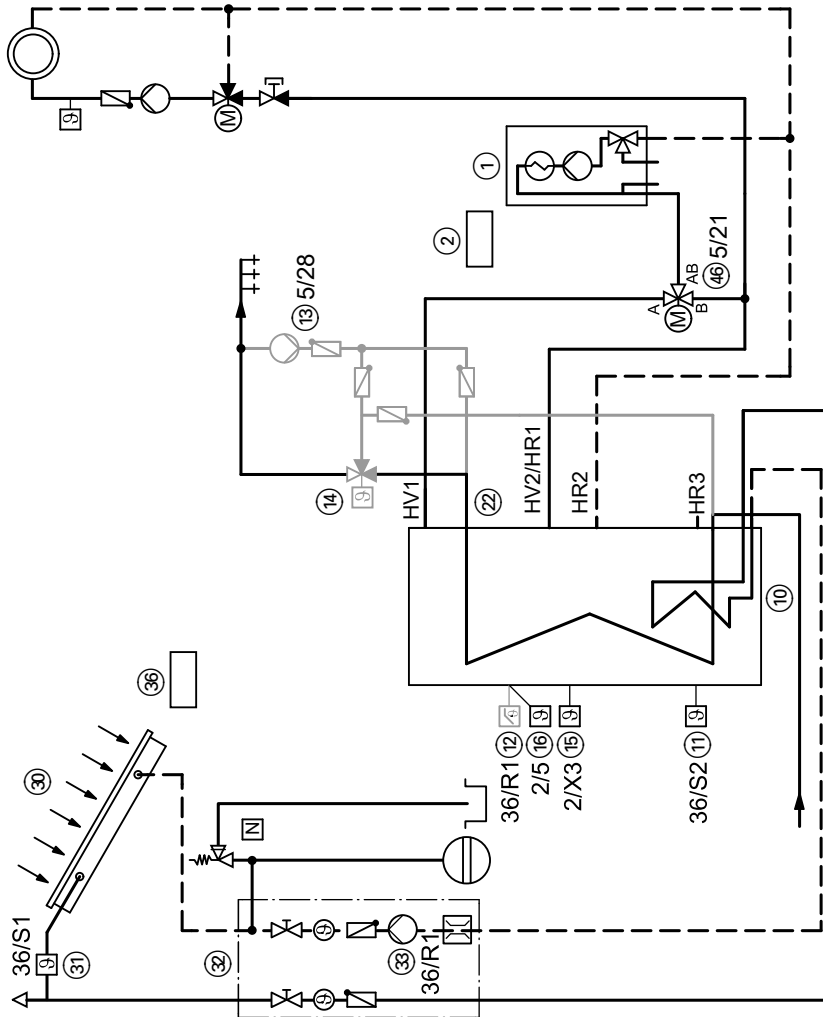

System example 2 (cont.)

Equipment required

Pos.	Description
①	Wall mounted gas boiler
	with
②	Boiler and heating circuit control unit
③	Internal extension H1 (standard delivery for the Vitodens 300-W)
	or
④	Internal extension H2 (accessory)
	or
	System with DHW circulation pump:
⑤	External extension H1 (accessory)
⑥	KM BUS distributor (accessory)
⑩	Heating water buffer cylinder
	with
⑫	Threaded DHW circulation pump (accessory)
⑮	Temperature sensor (flow temperature sensor for low loss header; in this scheme with heating water buffer cylinder) (accessory)
⑯	Cylinder temperature sensor (accessory)
⑪	Cylinder temperature sensor S2
⑫	High limit safety cut-out (accessory)
⑬	DHW circulation pump (on site)
⑭	Thermostatic mixing valve (accessory)
⑳	Solar collectors
㉑	Collector temperature sensor S1
㉒	Solar-Divicon (accessory)
	with
㉓	Solar circuit pump R1
㉔	Vitosolic 100, type SD1
㉕	Junction box (on site)
㉖	ON/OFF switch (on site)
㉗	Three-way diverter valve (accessory)

Preparing for installation

System example 2 (cont.)

Electrical installation diagram

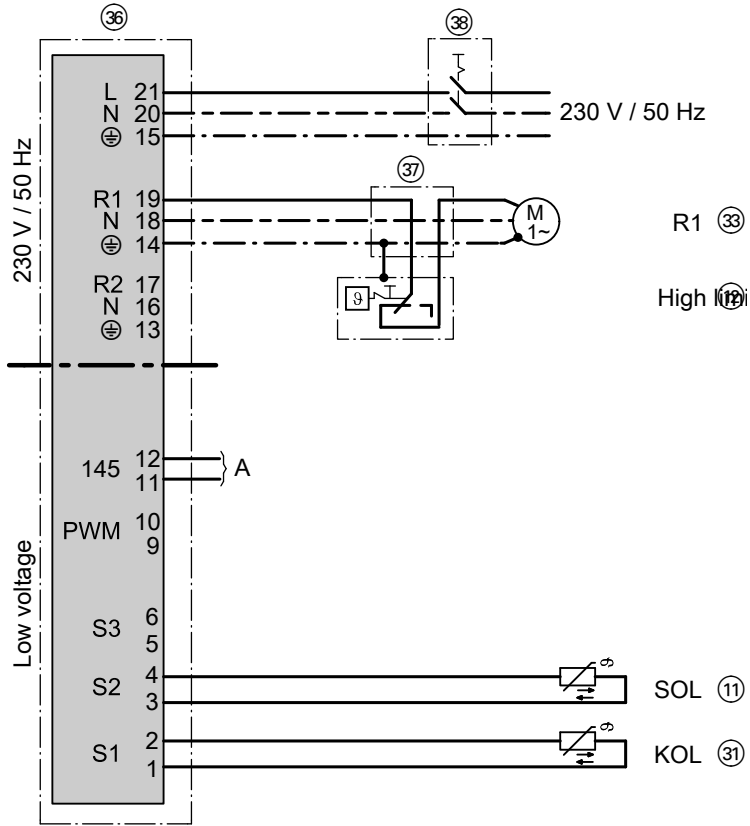

System example 2 (cont.)

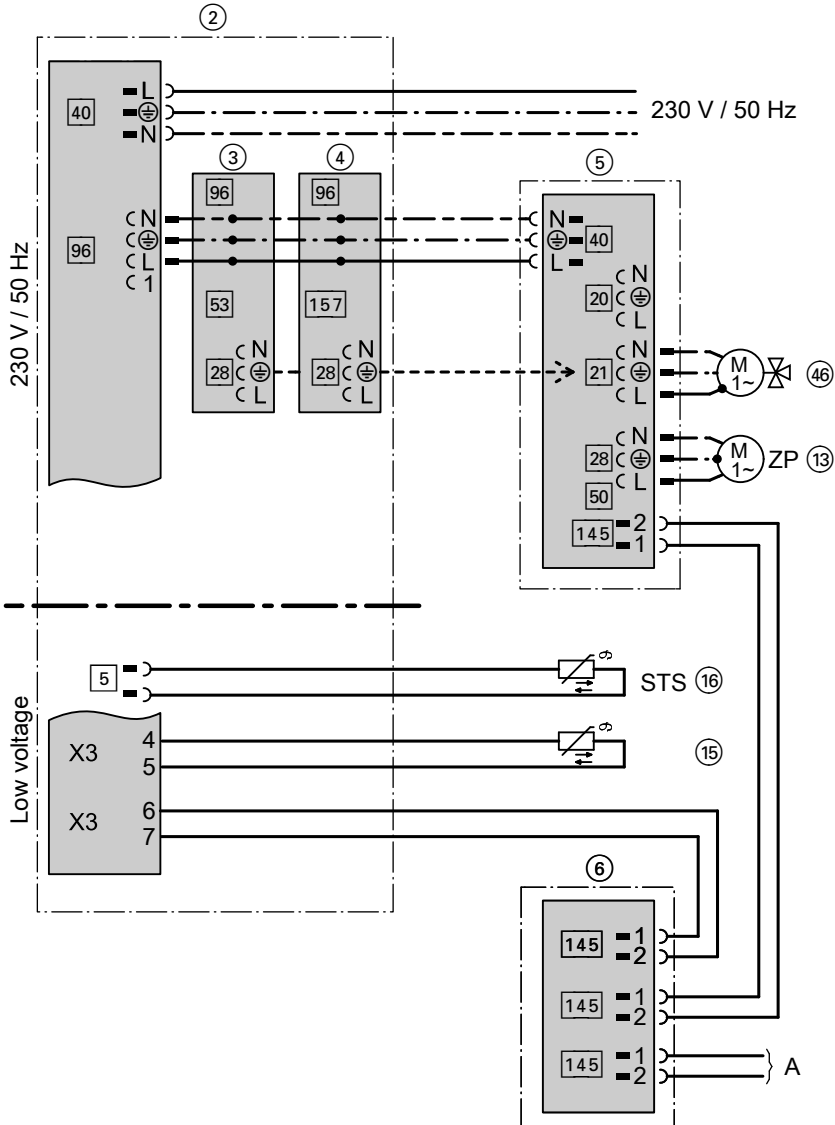

Installation

System example 3

Vitodens – DHW heating with freshwater module and central heating backup with heating water buffer cylinder

Main components

- Viessmann solar collectors
- Freshwater module
- Heating water buffer cylinder Vitocell140-E or Vitocell 160-E
- Vitosolic 100, type SD1
- Solar-Divicon
- Wall mounted gas boiler from the year of manufacture 2008
 - Vitodens 200-W, type WB2B
 - Vitodens 300-W, type WB3C

Function description

Freshwater module (10) heats DHW when hot water is drawn. The energy supply to freshwater module (10) is provided via heating water buffer cylinder (40).

DHW heating with solar energy

Solar circuit pump R1 (33) starts and heating water buffer cylinder (40) is heated up if the temperature differential between collector temperature sensor S1 (31) and cylinder temperature sensor S2 (41) exceeds the start temperature differential DT E.

Solar circuit pump R1 (33) is stopped in accordance with the following criteria:

- The actual temperature falls below the shutdown temperature differential DT A.
- Exceeding the electronic temperature limit (max. 90°C) of control unit (36)
- Reaching the temperature selected at high limit safety cut-out (44) (if installed)

Entire heating water buffer cylinder (40) is heated by the solar thermal system if the insolation is adequate.

The upper part of heating water buffer cylinder (40) will only be reheated by boiler (1) if the actual water temperature falls below the set temperature selected at boiler control unit (2).

The burner is started and three-way diverter valve (46) is switched to position "AB-A" via cylinder temperature sensor (42) of the boiler control unit. When the set DHW temperature has been reached, the burner is stopped and three-way diverter valve (46) is switched to position "AB-B".

Suppression of DHW cylinder reheating by the boiler

Coding address "67" in boiler control unit (2) defaults a third set DHW temperature (setting range 10 to 95 °C). This value must be below the first set DHW temperature. Heating water buffer cylinder (40) is only heated by the boiler (solar circuit pump R1 (33) runs) if this set value cannot be achieved by the solar thermal system.

DHW heating without solar energy

The upper area of heating water buffer cylinder (40) is heated by boiler (1). The cylinder thermostat with cylinder temperature sensor (42) of boiler control unit (2) controls three-way diverter valve (46).

System example 3 (cont.)

Central heating with solar energy

Central heating is provided via heating water buffer cylinder (40) if the temperature at sensor (43) is adequate.

Central heating without solar energy

If the temperature at sensor (43) is inadequate, the burner and circulation pump in the Vitodens are started. The area between HV3/HR1 and HR3 in heating water buffer cylinder (40) is heated up to the set temperature for the heating circuits in weather-compensated mode. When this set temperature is exceeded, the burner and, after a delay, the circulation pump in the Vitodens are stopped.

Required settings on the solar control unit

Parameters	Delivered condition	Description	Setting
ANL	1	Without auxiliary function for DHW heating	1
DT E	8 K	Start temperature differential for solar circuit pump at R1	
DT A	4 K	Stop temperature differential for solar circuit pump at R1	
S SL	60 °C	Set cylinder temperature (see page 53)	

For further functions, see chapter "Functions" from page 49.

Note

"DT E" can be set at least 0.5 K higher than "DT A".

"DT A" can be set up to 0.5 K below "DT E".

Information regarding speed control of the solar circuit pump

Observe chapter "Speed control" (see page 64).

Codes required at the boiler and heating circuit control unit

Code	Function
51:1	The internal circulation pump is only switched on when the burner has been started (time delay off)
53:3	System without DHW circulation pump: Three-way diverter valve (46) is connected to output [28] of internal extension H1 or H2
5b:1	Internal diverter valve without function (DHW cylinder connected downstream of the low loss header)

System example 3 (cont.)

Hydraulic installation diagram

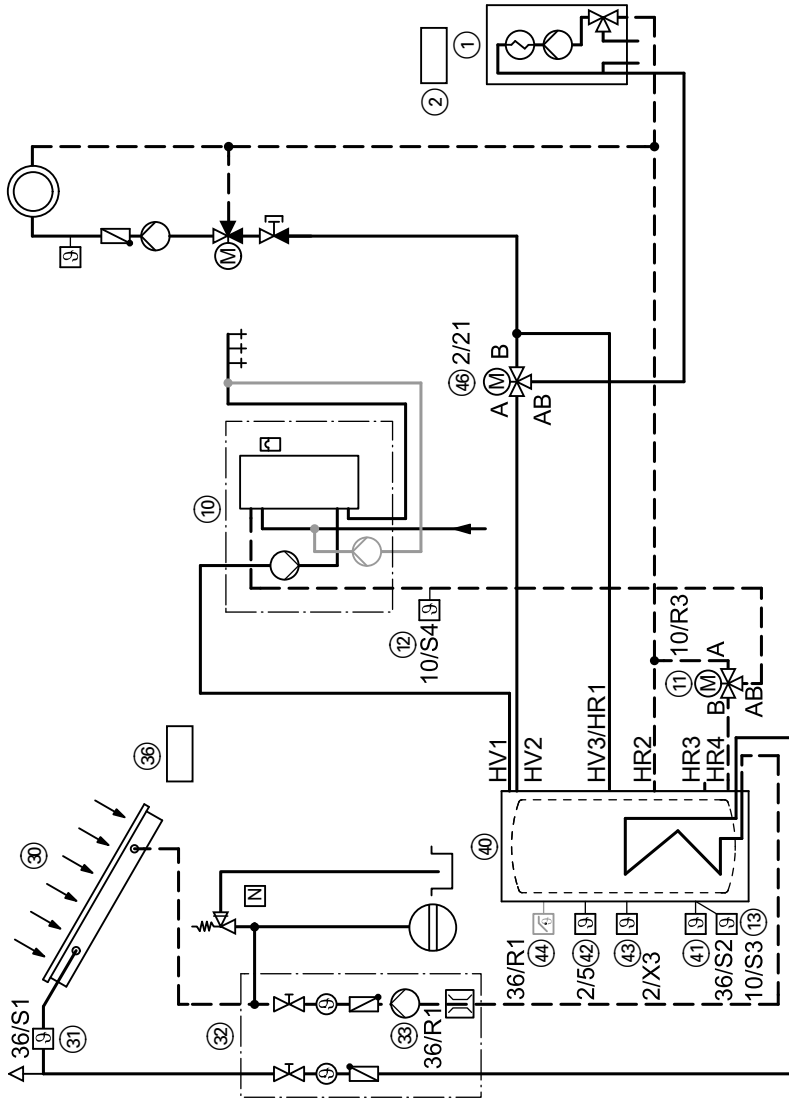

System example 3 (cont.)

Equipment required

Pos.	Description
①	Wall mounted gas boiler with
②	Boiler and heating circuit control unit
④②	Cylinder temperature sensor STS
③	Internal extension H1 (standard delivery for the Vitodens 300-W) or
④	Internal extension H2 (accessory)
⑩	Freshwater module with
⑪	Three-way diverter valve R3 and
⑫	Temperature sensor S4 and
⑬	Temperature sensor S3
⑭	ON/OFF switch (on site)
④①	Heating water buffer cylinder
④①	Cylinder temperature sensor S2
④④	High limit safety cut-out (accessory)
③①	Solar collectors
③①	Collector temperature sensor S1
③②	Solar-Divicon (accessory) with
③③	Solar circuit pump R1
③⑥	Vitosolic 100, type SD1
③⑦	Junction box (on site)
③⑧	ON/OFF switch (on site)
④③	Temperature sensor (flow temperature sensor for low loss header) (accessory)
④⑥	Three-way diverter valve (accessory)

Preparing for installation

System example 3 (cont.)

Electrical installation diagram

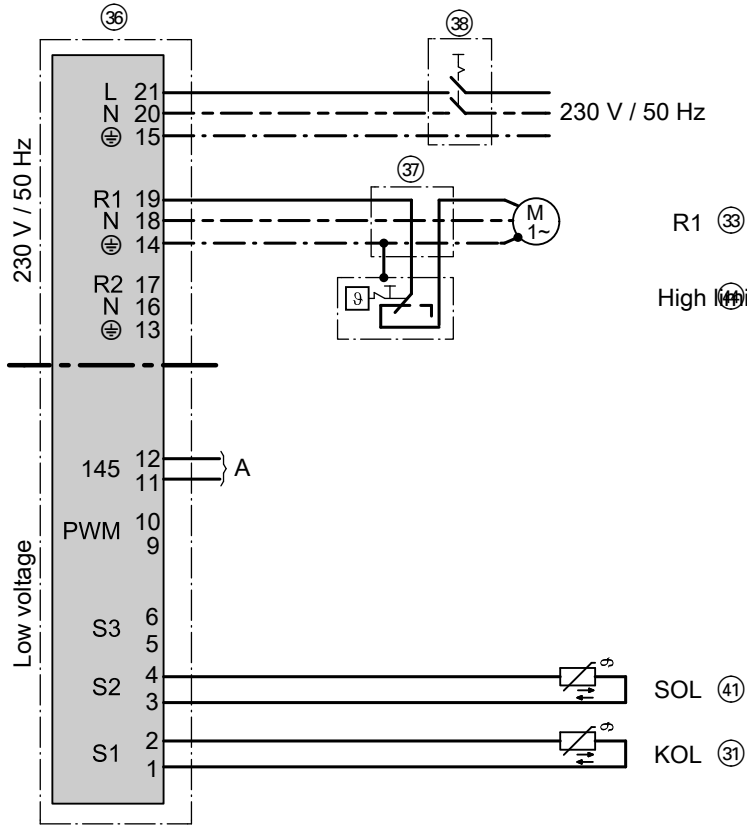

System example 3 (cont.)

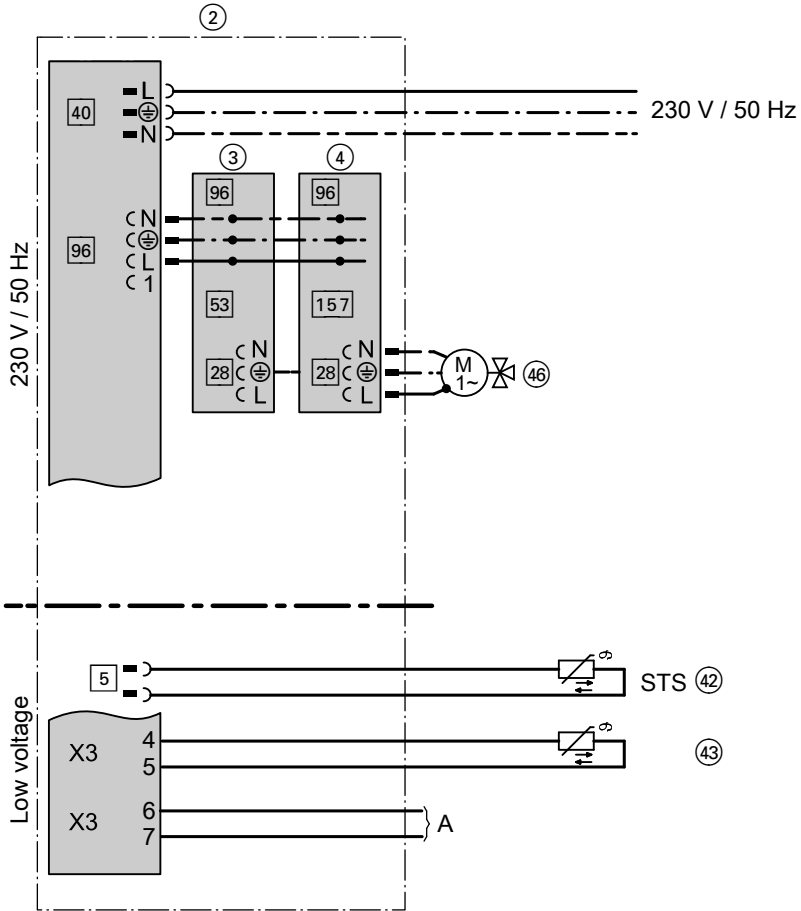

Installation

System example 3 (cont.)

Control unit, freshwater module

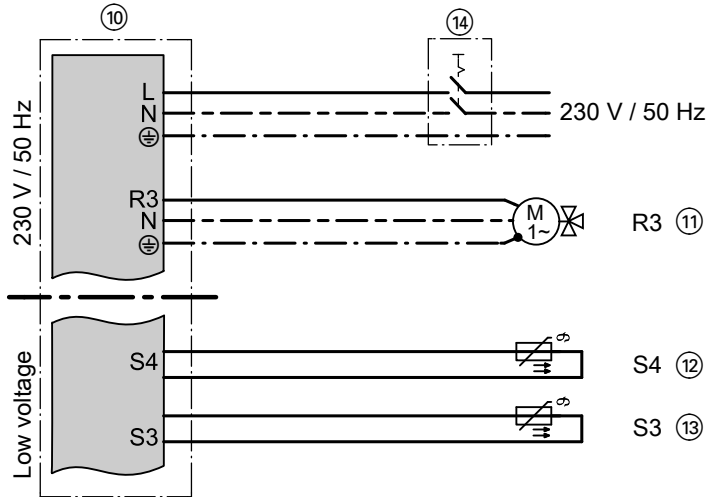

System example 4

DHW heating with solar retrofit system

There are two control versions for this system example:

- Anti-stratification with sensor S3 in DHW cylinder 2 (existing)
- Anti-stratification with sensor S3 in DHW cylinder 1 (retrofit)

Anti-stratification with sensor S3 in DHW cylinder 2 (existing)

Main components

- Viessmann solar collectors
- Mono-mode DHW cylinder (existing)
- Solar retrofit system with the following components:
 - Solar-Divicon
 - Vitosolic 100, type SD1
 - DHW cylinder Vitocell 100-W, type CUG
- Wall mounted oil/gas boiler or oil/gas boiler (existing)

System example 4 (cont.)

Function description

DHW heating with solar energy

Solar circuit pump R1 (10) starts and DHW cylinder (10) is heated up if the temperature differential between collector temperature sensor S1 (33) and cylinder temperature sensor S2 (11) exceeds the start temperature differential DT E. Solar circuit pump R1 (33) is stopped in accordance with the following criteria:

- The actual temperature falls below the shutdown temperature differential DT A.
- Exceeding the electronic temperature limit (max. 90°C) of control unit (36)
- Reaching the temperature selected at high limit safety cut-out (12) (if installed)

Anti-stratification pump R2 (15) starts if the temperature differential between sensor S2 (11) and sensor S3 (17) exceeds the start temperature differential DT 3E. The water heated in DHW cylinder (10) is transferred to DHW cylinder 2 (18).

The anti-stratification pump R2 will also start if there is a demand for DHW heating issued by the auxiliary function.

Anti-stratification pump R2 (15) stops in accordance with the following criteria:

- The actual temperature falls below the shutdown temperature differential DT 3A
 - When the auxiliary function for DHW heating ends
- DHW circulation pump (13) (if installed) for DHW cylinder 2 (18) is controlled by boiler control unit (2).

Suppression of DHW cylinder reheating by the boiler

Coding address "67" in boiler control unit (2) defaults a third set DHW temperature (setting range 10 to 95 °C). This value must be below the first set DHW temperature. DHW cylinder 2 (18) will only be heated by boiler (1) (solar circuit pump R1 (33) runs) if this set value cannot be achieved by the solar thermal system.

DHW heating without solar energy

DHW cylinder 2 (18) is heated by boiler (1). The cylinder thermostat with cylinder temperature sensor (3) of boiler control unit (2) regulates cylinder heating.

Required settings on the solar control unit

Parameters	Delivered condition	Description	Setting
ANL	1	With auxiliary function for DHW heating (see page 56)	8
DT E	8 K	Start temperature differential for solar circuit pump at R1	
DT A	4 K	Stop temperature differential for solar circuit pump at R1	



Preparing for installation

System example 4 (cont.)

Parameters	Delivered condition	Description	Setting
DT 3E	8 K	Start temperature differential for anti-stratification pump at R2	
DT 3A	4 K	Stop temperature differential for anti-stratification pump at R2	
S SL	60 °C	Set cylinder temperature (see page 53)	

For further functions, see chapter "Functions" from page 49.

Note

*"DT E/DT 3E" can be set to at least 0.5 K above "DT A/DT 3A".
"DT A/DT 3A" can be set up to 0.5 K below "DT E/DT 3E".*

Information regarding speed control of the solar circuit pump

Observe chapter "Speed control" (see page 64).

System example 4 (cont.)

Hydraulic installation diagram

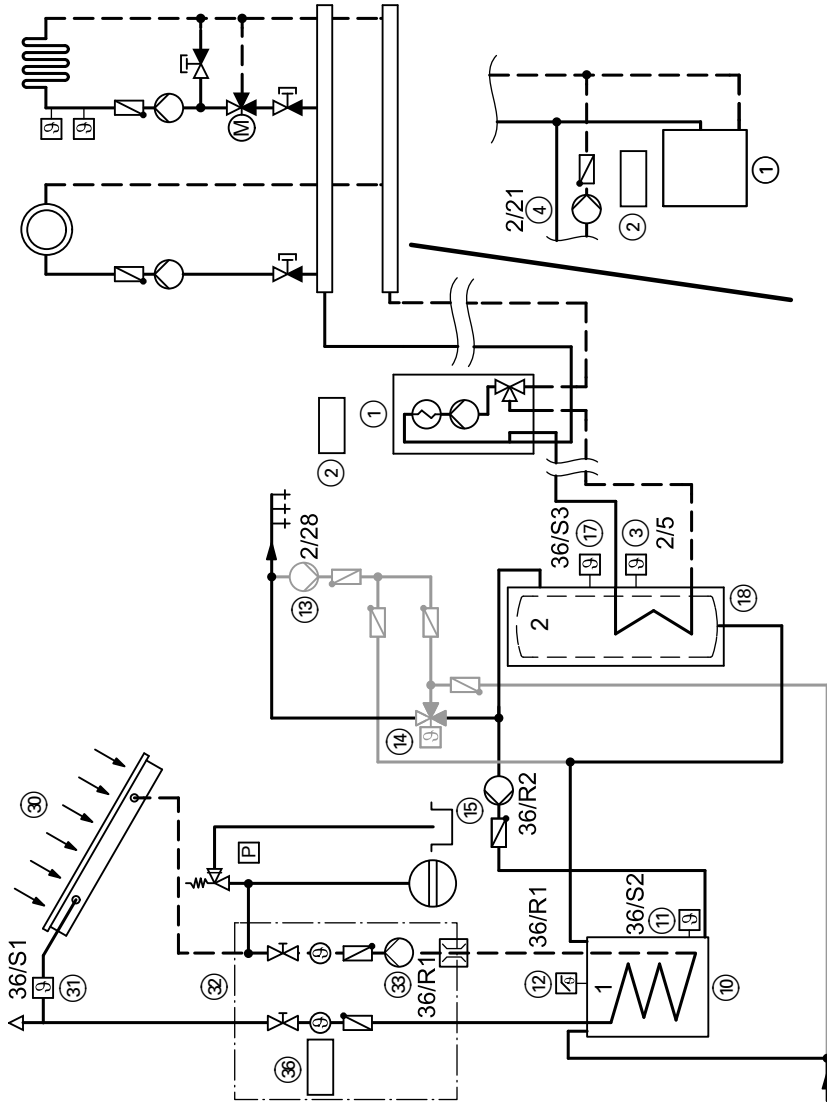

Installation

System example 4 (cont.)

Equipment required

Pos.	Description
①	Oil/gas boiler or wall mounted oil/gas boiler with
②	Boiler and heating circuit control unit
③	Cylinder temperature sensor
④	Circulation pump for cylinder heating (integrated for wall mounted oil/gas boiler)
⑱	DHW cylinder 2, mono-mode (existing)
⑩	DHW cylinder 1, mono-mode (solar retrofit system)
⑪	Cylinder temperature sensor S2
⑫	High limit safety cut-out (accessory)
⑬	DHW circulation pump (on site) (internal/external extension may be required for connecting a wall mounted oil/gas boiler)
⑭	Thermostatic mixing valve (accessory)
⑳	Solar collectors
㉑	Collector temperature sensor S1
㉒	Solar-Divicon (solar retrofit system) with
㉓	Solar circuit pump R1 and
㉔	Vitosolic 100, type SD1
㉕	Junction box (on site)
㉖	ON/OFF switch (on site)
DHW circulation diversion	
⑮	Circulation pump R2 (anti-stratification) (accessory)
⑰	Temperature sensor S3 (DHW cylinder 2) (accessory)

System example 4 (cont.)

Electrical installation diagram

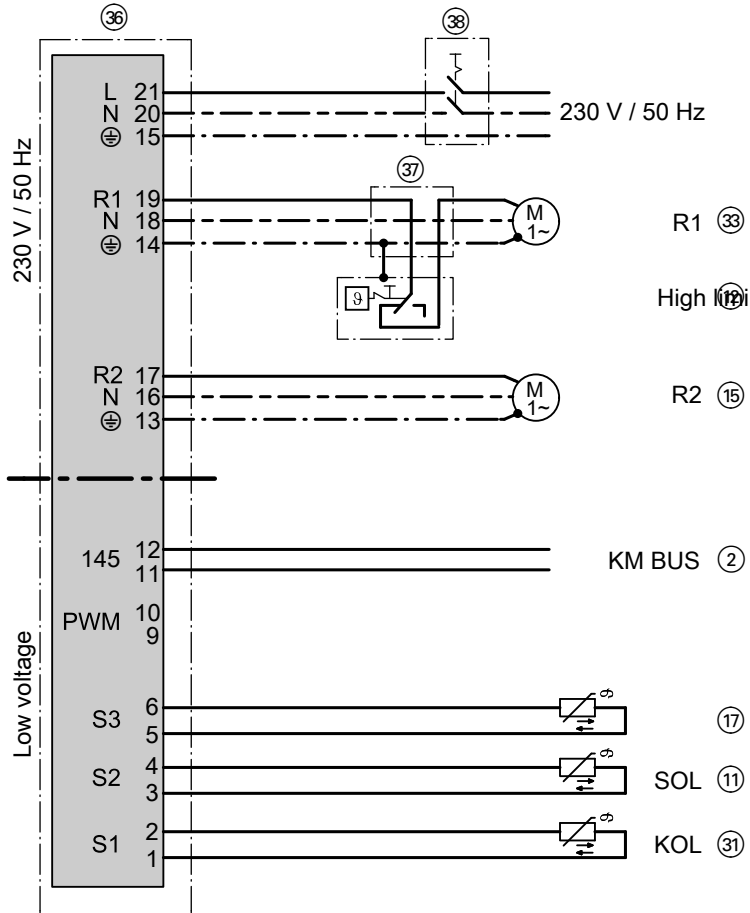

Installation

Anti-stratification with sensor S3 in DHW cylinder 1 (retrofit)

Main components

- Viessmann solar collectors
- Mono-mode DHW cylinder (existing)
- Solar retrofit system with the following components: ▶▶

System example 4 (cont.)

- Solar-Divicon
- Vitosolic 100, type SD1
- DHW cylinder Vitocell 100-W, type CUG
- Wall mounted oil/gas boiler or oil/gas boiler (existing)

Function description

DHW heating with solar energy

Solar circuit pump R1 (33) starts and DHW cylinder (10) is heated up if the temperature differential between collector temperature sensor S1 (31) and cylinder temperature sensor S2 (11) exceeds the start temperature differential DT E.

Solar circuit pump R1 (33) is stopped in accordance with the following criteria:

- The actual temperature falls below the shutdown temperature differential DT A.
- Exceeding the electronic temperature limit (max. 90°C) of control unit (36)
- Reaching the temperature selected at high limit safety cut-out (12) (if installed)

Anti-stratification pump R2 (15) starts if the temperature at sensor S3 (17) exceeds the start temperature NH E.

The water heated in DHW cylinder (10) is transferred to DHW cylinder 2 (18).

The anti-stratification pump R2 will also start if there is a demand for DHW heating issued by the auxiliary function.

Anti-stratification pump R2 (15) stops in accordance with the following criteria:

- The actual temperature falls below the stop temperature N HA
- When the auxiliary function for DHW heating ends

DHW circulation pump (13) (if installed) for DHW cylinder 2 (18) is controlled by boiler control unit (2).

Suppression of DHW cylinder reheating by the boiler

Coding address "67" in boiler control unit (2) defaults a third set DHW temperature (setting range 10 to 95 °C). This value must be below the first set DHW temperature. DHW cylinder 2 (18) will only be heated by boiler (1) (solar circuit pump R1 (33) runs) if this set value cannot be achieved by the solar thermal system.

DHW heating without solar energy

DHW cylinder 2 (18) is heated by boiler (1). The cylinder thermostat with cylinder temperature sensor (3) of boiler control unit (2) regulates cylinder heating.

System example 4 (cont.)

Required settings on the solar control unit

Parameters	Delivered condition	Description	Setting
ANL	1	With auxiliary function for DHW heating (see page 56)	9
DT E	8 K	Start temperature differential for solar circuit pump at R1	
DT A	4 K	Stop temperature differential for solar circuit pump at R1	
N HE	40 °C	Start temperature for anti-stratification pump at R2	WW _{set} + 4 K
N HA	45 °C	Stop temperature for anti-stratification pump at R2	WW _{set} + 2 K
S SI	60 °C	Set cylinder temperature (see page 53)	

For further functions, see chapter "Functions" from page 49.

Note

- **"DT E"** can be set at least 0.5 K higher than **"DT A"**.
- **"DT A"** can be set up to 0.5 K below **"DT E"**.
- WW_{set} is the set DHW temperature of the DHW cylinder 2 (existing). Scan this value at the boiler control unit. When adjusting **"N HE"** observe the set cylinder temperature **"S SL"**. If necessary, adjust the set DHW temperature of DHW cylinder 2 a little lower at the boiler control unit.

Information regarding speed control of the solar circuit pump

Observe chapter "Speed control" (see page 64).



Installation and service instructions of the boiler control unit

System example 4 (cont.)

Hydraulic installation diagram

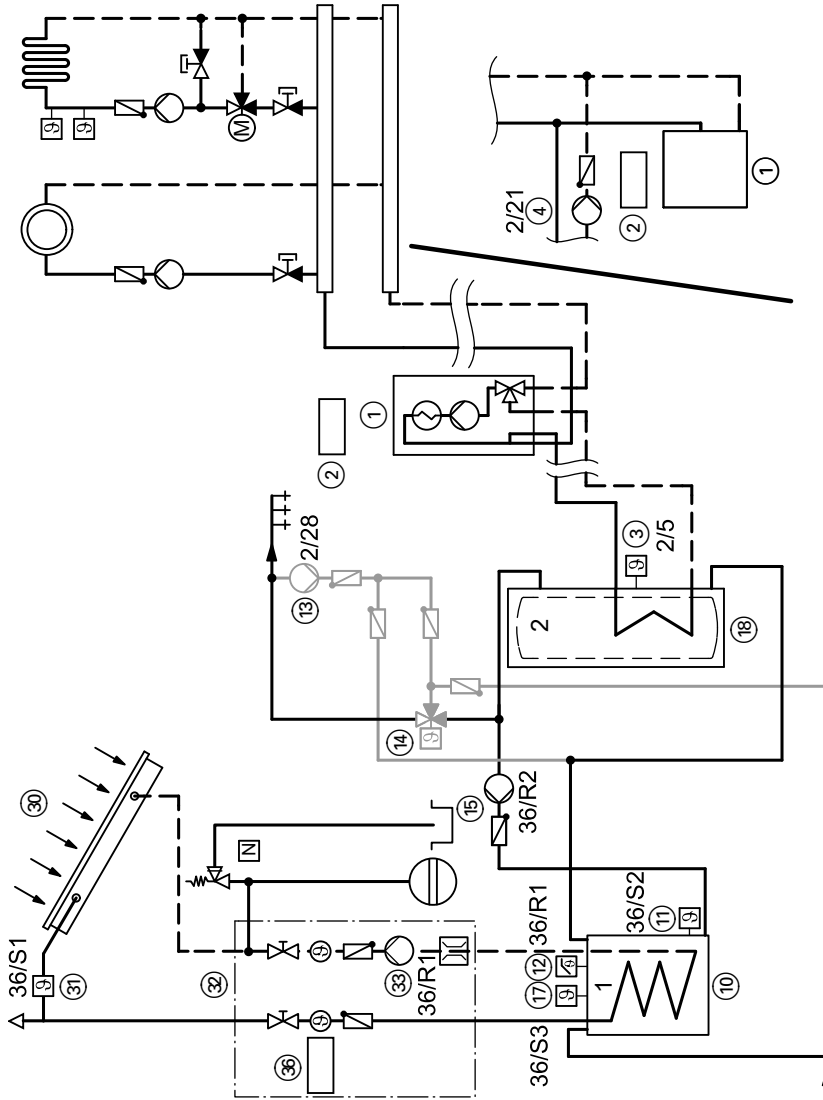

System example 4 (cont.)

Equipment required

Pos.	Description
①	Oil/gas boiler or wall mounted oil/gas boiler
	with
②	Boiler and heating circuit control unit
③	Cylinder temperature sensor
④	Circulation pump for cylinder heating (integrated for wall mounted oil/gas boiler)
⑱	DHW cylinder 2, mono-mode (existing)
⑩	DHW cylinder 1, mono-mode (solar retrofit system)
⑪	Cylinder temperature sensor S2
⑫	High limit safety cut-out (accessory)
⑬	DHW circulation pump (on site) (internal/external extension may be required for connecting a wall mounted oil/gas boiler)
⑭	Thermostatic mixing valve (accessory)
⑳	Solar collectors
㉑	Collector temperature sensor S1
㉒	Solar-Divicon (solar retrofit system)
	with
㉓	Solar circuit pump R1 and
㉔	Vitosolic 100, type SD1
㉕	Junction box (on site)
㉖	ON/OFF switch (on site)
	DHW circulation diversion
⑮	Circulation pump R2 (anti-stratification) (accessory)
⑰	Temperature sensor S3 (DHW cylinder 1) (accessory)

System example 4 (cont.)

Electrical installation diagram

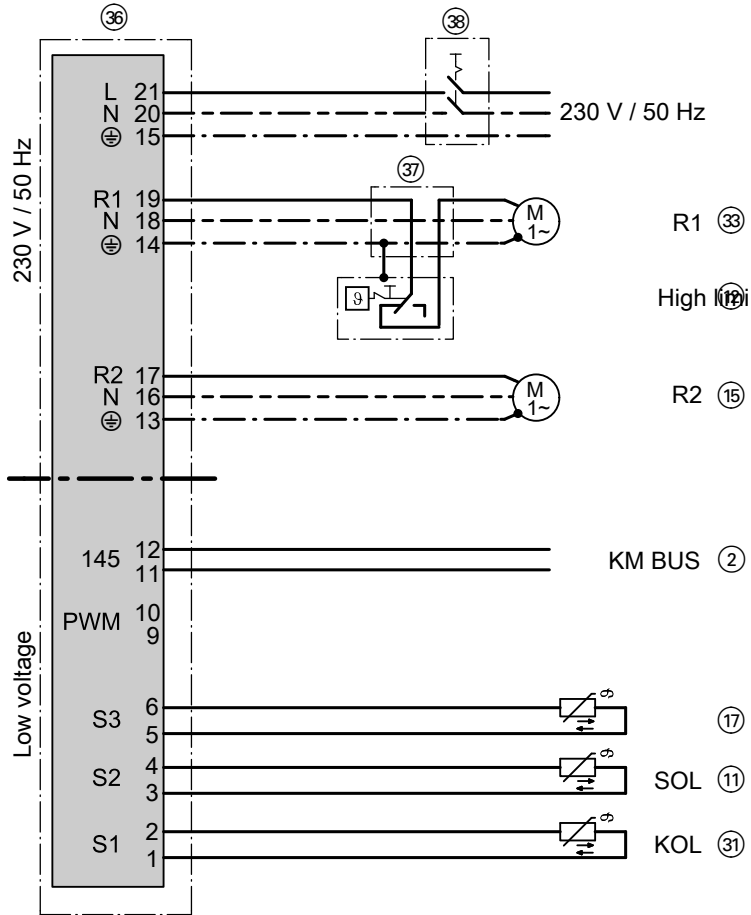

Fitting the solar control unit

Select an installation location near the DHW cylinder, considering the electrical connections and their cable lengths.

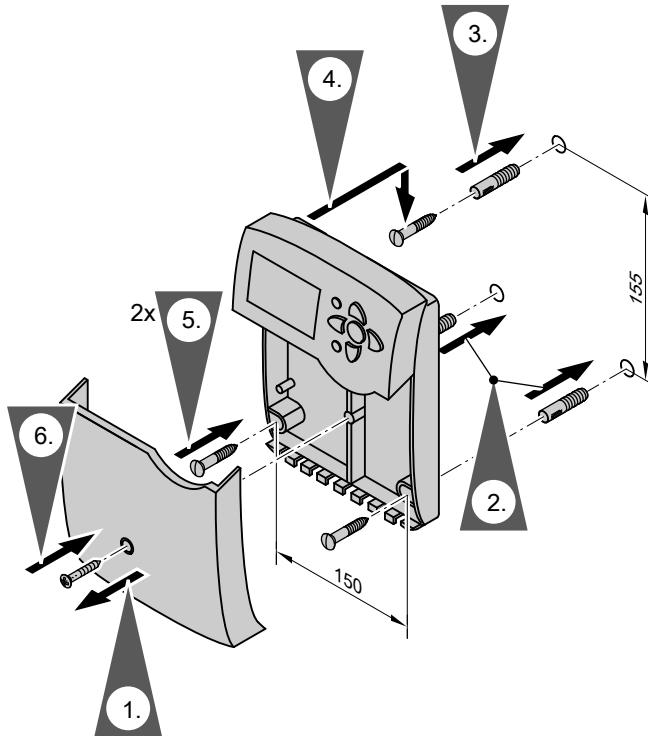

Before closing the solar control unit, make all electrical connections and apply a strain relief to all cables/leads.

Installation sequence

Overview of electrical connections

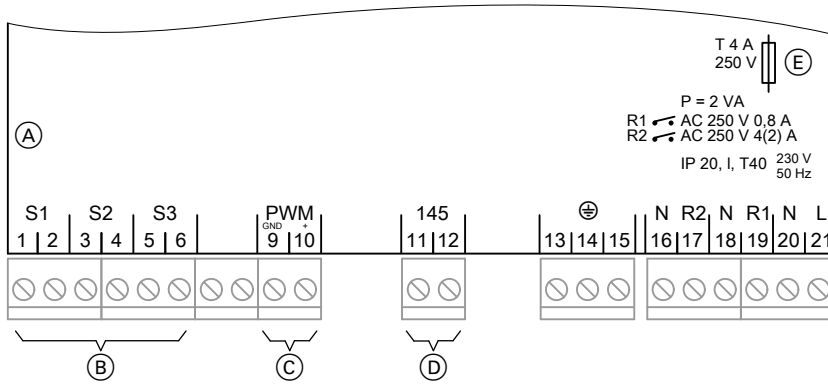

- (A) Wiring chamber of the solar control unit

(B) Sensor inputs

(C) PWM signal for the solar circuit pump
- (D) KM BUS

(E) Fuse, 4.0 A (slow)

R1 Semiconductor relay (suitable for speed control)

R2 Electromechanical relay

Solar circuit pump

Possible pumps

Standard solar circuit pumps		High efficiency pumps	Pumps with PWM input
Without individual speed control (with integral auxiliary capacitor)	With individual speed control		Note <i>Use only solar pumps, not heating circuit pumps.</i>
"RPM" = 1	"RPM" = 0	"RPM" = 0	<ul style="list-style-type: none"> ■ WILO pumps: "RPM" = 2 ■ GRUNDFOS pumps: "RPM" = 3

Solar circuit pump (cont.)

Installation

The circulation pump with connecting cable is part of the Solar-Divicon pump station.

Alternative pumps must be type-tested and installed in accordance with the manufacturer's details.



Separate installation and service instructions

Connection

3-core cable with a cross-section of 0.75 mm².
Rated current: 0.8 A

Note

Pumps that draw more than 190 W must be connected via an additional relay (coupler relay). Disable the speed control for this pump (see chapter "Speed control").

Standard pump

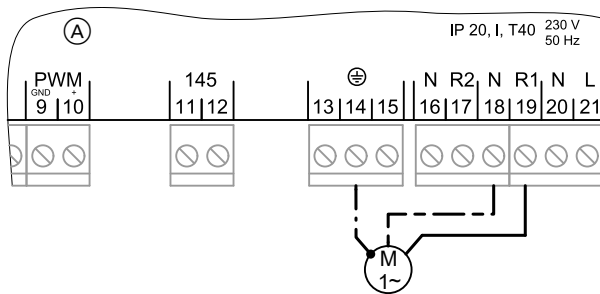

- Ⓐ Wiring chamber of the solar control unit R1 Solar circuit pump

Installation sequence

Solar circuit pump (cont.)

Pump with PWM input

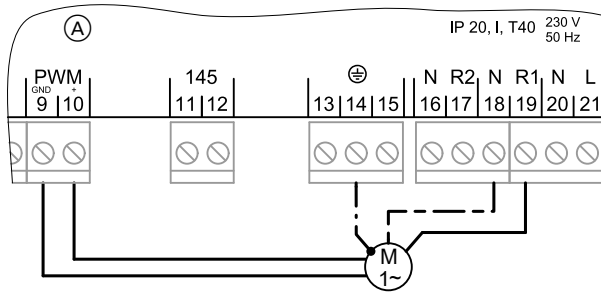

Ⓐ

Wiring chamber of the solar control unit

R1/PWM Solar circuit pump

Pump/valve at output R2

Installation

Pump and valve must be type-tested and installed in accordance with manufacturer's details.

Connection

3-core cable with a cross-section of 0.75 mm².

Rated current: max. 4(2) A

Pump/valve at output R2 (cont.)

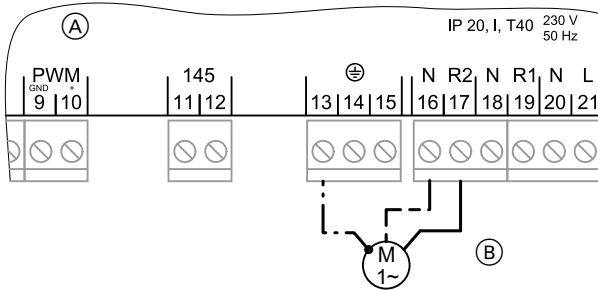

- (A) Wiring chamber of the solar control unit (B) Pump or valve

High limit safety cut-out

A high limit safety cut-out in the consumer is required when less than 40 litres cylinder volume is available per m² absorber area. This installation safely prevents temperatures in excess of 90 °C in the consumer.

Note

For the Vitocell 100, observe the max. collector area that can be connected.

Installation

Install the sensor of the high limit safety cut-out inside the cylinder cap (Vitocell 300 accessory).



Cylinder cap installation instructions

Connection

3-core cable with a cross-section of 1.5 mm².

Installation sequence

High limit safety cut-out (cont.)

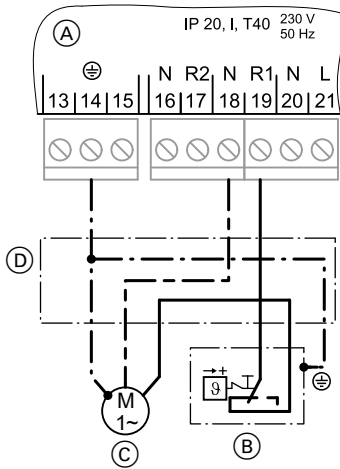

- (C) Solar circuit pump
- (D) Junction box (on site)

- (A) Wiring chamber of the solar control unit
- (B) High limit safety cut-out

Temperature setting

Delivered condition: 120 °C
Requires adjustment to 95 °C

 High limit safety cut-out installation instructions

Collector temperature sensor

Installation



Collector installation instructions

Connection

Connect the sensor to S1 (terminals 1 and 2).
Extension of the connecting lead:
2-core cable with a cross-section of
1.5 mm².

Note

Never route this lead immediately next to 230/400 V cables.

Cylinder temperature sensor

Installation

With the threaded elbow.



DHW cylinder installation instructions

Connection

Connect the sensor to S2 (terminals 3 and 4).

Extension of the connecting lead:
2-core cable with a cross-section of
1.5 mm².

Note

*Never route this lead immediately next to
230/400 V cables.*

Temperature sensor

Installation

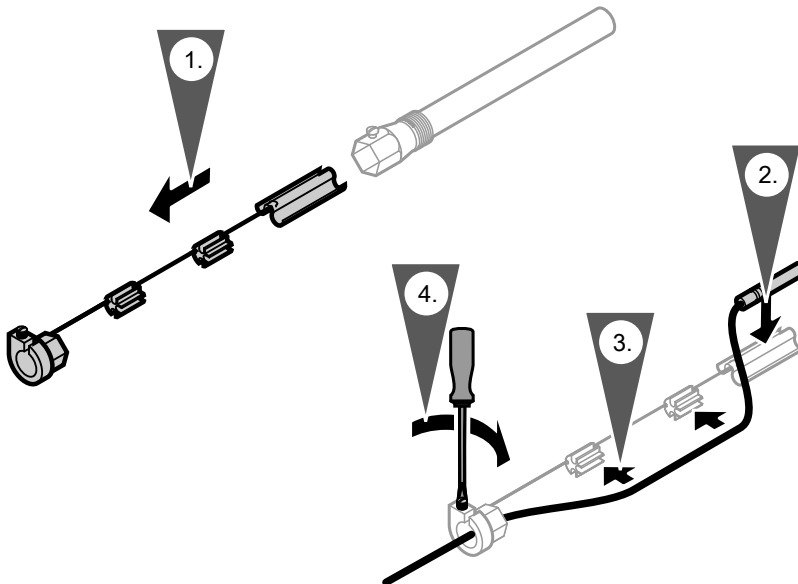

Installation sequence

Temperature sensor (cont.)

Note

Never wrap insulating tape around the sensor.

Seal in the sensor well.

Connection

Connect the sensor to S3 (terminals 5 and 6).

Extension of the connecting lead:
2-core cable with a cross-section of
1.5 mm².

Note

Never route this lead immediately next to 230/400 V cables.

Power supply

Regulations

Carry out the power supply connection and all earthing measures (i.e. RCD circuit) in accordance with IEC 364, the requirements of your local power supply utility, VDE or national regulations.

Protect the power cable to the control unit with an appropriate fuse/MCB.

Power supply (cont.)

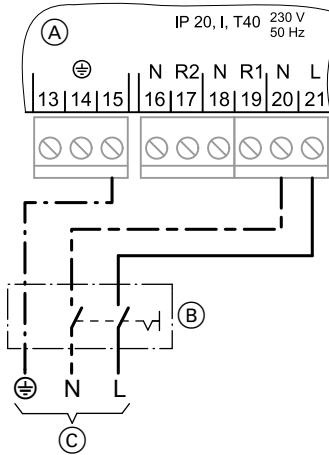

- (A) Solar control unit wiring chamber
- (B) ON/OFF switch (on site)
- (C) Mains voltage 230 V/50 Hz

Provide the power supply connection (230 V~) via a two-pole mains isolator (on-site).

Disconnect the system by means of a device which simultaneously separates all non-earthed conductors with at least 3 mm contact separation.



Danger

Incorrect core termination can cause severe injuries and damage to the equipment.

Never interchange cores "L" and "N":

L Terminal 21

N Terminal 20

Commissioning

Switching the power ON

1. Check whether all electrical connections have been correctly made.
2. Check that the high limit safety cut-out (if required) is connected.
3. Switch ON the power; the solar control unit then implements an initiation phase.
The solar control unit is now in automatic mode.
4. Check the type of solar circuit pump that is connected and set parameter **"RPM"** accordingly (see pages 36 and 45).

Navigation through the menu

- The display shows the collector temperature and the system scheme.
- Key **≡**:
Calling up the menu for setting the system parameters
The symbol line on the display shows which keys to use to make adjustments and scans.
- Flashing **"SET"**
Values can be changed
- Key **↩**
Terminating an adjustment already begun in the menu (the value reverts to its previous setting)
- **OK** key
Confirmation of the selection or value change made in the menu

Note

After approx. 4 min, the display changes to show the collector temperature, if no further adjustments are made.

Selecting the system scheme

Press the following keys:





1. **≡**: **"ANL 1"** and the display will show the respective scheme.
2. **OK** **"SET"** flashes.
3. **▶** for the required scheme.
4. **OK** to confirm.

Selecting the system scheme (cont.)

System schemes, see from page 51.

Setting system parameters

Press the following keys:







1.  **"ANL"** and the display will show the respective scheme.
2.  until the required parameter is shown (see table on page 49).
3. OK **"SET"** flashes.
4.  /  for the selected value.
5. OK to confirm.

Resetting system parameters

If a different system scheme is selected, all parameters are returned to their original state.

Carrying out a relay test

Press the following keys:

1.  **"ANL"** and the display will show the respective scheme.
2.  Select **"HND 1"** or **"HND 2"**.
HND 1 Relay 1
HND 2 Relay 2
3. OK **"SET"** flashes.
4.  /  for the required setting.
Auto Control mode
On in (100%)
 and "ⓘ" or "Ⓜ" are displayed and "⚠" flashes.
OFF OFF
 is shown and "⚠" flashes.
5. OK to confirm.
6. After the relay test has been completed, select **"Auto"**.

Service scans

Scanning temperatures and operating conditions

Subject to system configuration and settings made, the following values can be scanned with keys ▲ / ▼:

Display		Description
KOL	°C	Collector temperature
TSPU	°C	DHW temperature
S3	°C	Temperature at a sensor S3 that may be connected
n1	%	Relative speed of the solar circuit pump
n2		Status of relay R2: OFF: Relay off On: Relay on
hP1	h	Hours run of the device at output relay R1 (solar circuit pump)
hP2	h	Hours run of the device at output relay R2
kWh		Amount of heat if a heat meter is enabled
MWh		
		Note <i>Add the values for MWh and kWh together.</i>

Resetting the hours run and the energy volume

2. OK to confirm.

Whilst this value is displayed, press the following keys:

1. OK "SET" flashes; value 0 is displayed.

Fault messages

Sensor faults:

- Display background light flashes
- The sensor symbol in the system scheme flashes quickly
- \triangle flashes

Possible displays:

- 88.8 Sensor short circuit
- 888.8 Sensor break

Note

Further scans can be carried out with keys \blacktriangle / \blacktriangledown .

Example - collector temperature sensor short circuit



Checking sensors

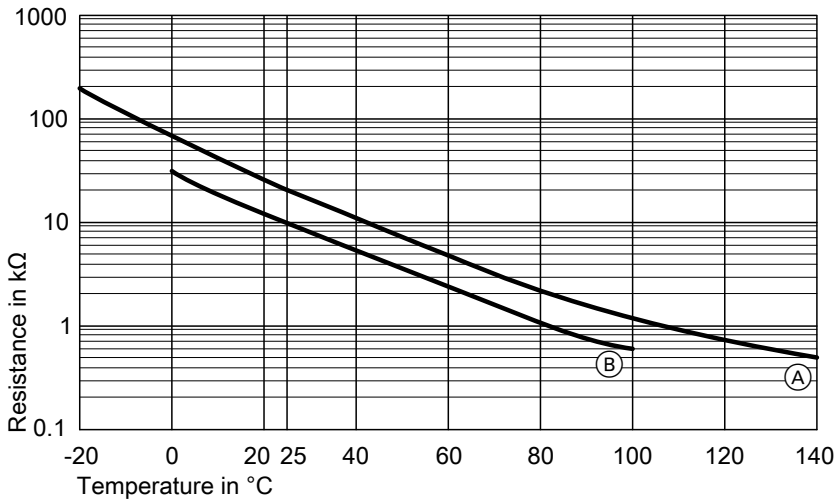

(A) Resistor 20 kΩ (sensor S1, collector temperature sensor)

(B) Resistor 10 kΩ (sensors S2 and S3)

5369 987 GB

1. Disconnect the respective sensor and measure its resistance.



Troubleshooting

Checking sensors (cont.)

2. Compare the measurement with the actual temperature (for scanning see page 46). Check the installation and, in case of severe deviation, replace the sensor.

Specification

Sensor NTC	10 k Ω at 25 °C	20 k Ω at 25 °C
Protection	IP 53	IP 53
Permissible ambient temperature		
■ during operation	-20 to + 90 °C	-20 to + 200 °C
■ during storage and transport	-20 to + 70 °C	-20 to + 70 °C

Changing the fuse

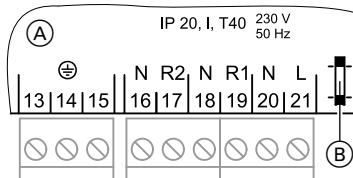

- (A) Solar control unit wiring chamber
- (B) Fuse, 4 A (slow)

Open the solar control unit wiring chamber.

A spare fuse is included in the fuse holder.

Parameter overview

The following parameters can be set subject to the actual system configuration:

Display	Parameters	Delivered condition	Setting range	System scheme
ANL	System scheme	1	1–10	—
DT E	Start temperature differential for solar circuit pump R1	8 K	1.5 – 20 K	1 to 9
DT A	Stop temperature differential for solar circuit pump R1	4 K	1.0 – 19.5 K	
S SL	Set cylinder temperature (see page 53)	60 °C	4 – 90 °C	
DT 1E	Start temperature differential for solar circuit pump R1 (consumer 1)	8 K	1.5 – 20 K	
DT 1A	Stop temperature differential for solar circuit pump R1 (consumer 1)	4 K	1.0 – 19.5 K	10
S 1SL	Set cylinder temperature (consumer 1) (see page 53)	60 °C	4 – 90 °C	
DT 2E	Start temperature differential for solar circuit pump R1 and valve R2 (consumer 2)	8 K	1.5 – 20 K	
DT 2A	Stop temperature differential for solar circuit pump R1 and valve R2 (consumer 2)	4 K	1.0 – 19.5 K	
S 2SL	Set cylinder temperature (consumer 2) (see page 53)	60 °C	4 – 90 °C	1 to 10
NOT	Collector limit temperature (see page 62)	130 °C	110 – 200 °C	
OKX	Collector cooling function (maximum collector temperature limit) (see page 62)	OFF	OFF/ON	
KMX		110 °C	90 – 190 °C	
OKN	Minimum collector temperature limit (see page 62)	OFF	OFF/ON	
KMN		10 °C	10 – 90 °C	
OKF	Frost protection (see page 63)	OFF	OFF/ON	
KFR		4 °C	–10 – +10 °C	



Function description

Parameter overview (cont.)

Display	Parameters	Delivered condition	Setting range	System scheme
PRIO	Sequence in which the consumers are heated up	1	0 – 2	10
tSP	Pump run break duration, cycle pause time	2 min	1 – 30 min	
tUMW	Break intervals	15 min	1 – 30 min	
ORUE	Return cooling function (see page 63)	OFF	OFF/ON	1 to 10
ORK	Interval function (see page 63)	OFF	OFF/ON	
DT 3E	Start temperature differential for anti-stratification pump R2	8 K	0 – 20 K	7
DT 3A	Stop temperature differential for anti-stratification pump R2	4 K	0.5 – 19.5 K	
MX3E	Maximum limit S3 on	58 °C	0 – 94.5 °C	
MX3A	Maximum limit S3 off	60 °C	0.5 – 95 °C	
MN3E	Minimum limit S3 on	10 °C	0.5 – 90 °C	
MN3A	Minimum limit S3 off	5 °C	0 – 89.5 °C	
NH E	Starting temperature for the thermostat function	40 °C	0 – 89.5 °C	3, 5, 9
NH A	Switch-off temperature for the thermostat function	45 °C	0.5 – 90 °C	3, 5, 9
OWMZ	Heat statement (see page 64)	OFF	OFF/ON	1 to 10
VMAX at 100% pump speed		5.0 l/min	0.1 – 20 l/min	
MEDT		3	0 – 3	
MED%		40	20 – 70	
RPM	Speed control (see page 64)	0	0 – 3	
n1MN ^{*1}	Minimum speed (see page 64)	30 %	30/20 – 100 %	

*1 Only adjustable with setting **RPM > 0**.

Parameter overview (cont.)

Display	Parameters	Delivered condition	Setting range	System scheme
DT S ^{*1}	Differential temperature for the start of the speed regulation (see page 64)	10 K	0.5 – 30 K	1 to 9
ANS ^{*1}	Rise (see page 64)	2 K	1 – 20 K	
DT 1S ^{*1}	Differential temperature for the start of speed regulation (consumer 1) (see page 64)	10 K	0.5 – 30 K	10
ANS1 ^{*1}	Rise (consumer 1) (see page 64)	2 K	1 – 20 K	
DT 2S ^{*1}	Differential temperature for the start of speed regulation (consumer 2) (see page 64)	10 K	0.5 – 30K	
ANS2 ^{*1}	Rise (consumer 2) (see page 64)	2 K	1 – 20 K	
HND1	Manual mode relay 1 (see page 45)	AUTO	OFF/ON	1 to 10
HND2	Manual mode relay 2 (see page 45)	AUTO	OFF/ON	
PROG	Software version of the solar control unit	—	—	—
VERS	Hardware version	—	—	—

System scheme

10 system schemes can be achieved with the solar control unit. Selection via parameter "**ANL**" (see page 44). All system schemes include the "**ANL 1**" functions (system scheme 1):

- Dual-mode DHW heating
- Suppression of reheating by the boiler in conjunction with control units with KM BUS
- Maximum DHW cylinder temperature limit

System scheme (cont.)

Auxiliary functions can be enabled for every system scheme.

- Collector limit temperature (see page 62)
- Collector cooling function (see page 62)
- Collector minimum temperature limit (see page 62)
- Frost protection function (see page 63)
- Reverse cooling function (see page 63)
- Interval function (see page 63)
- Heat statement (see page 64)
- Speed control (see page 64)

System scheme (cont.)

"ANL" = 1— Standard scheme

Dual-mode DHW heating with suppression of reheating by the boiler in conjunction with control units with KM BUS

Display

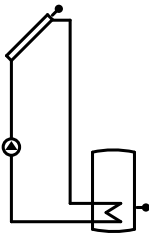

Temperature differential control

Determination of the temperature differential between collector temperature sensor S1 and cylinder temperature sensor S2.

- Solar circuit pump R1 on:
Exceeding "**DT E**"
- Solar circuit pump R1 off:
The actual temperature falls below the switch-off temperature differential "**DT A**"

Cylinder temperature limit

Solar circuit pump R1 off:
When reaching the set cylinder temperature "**S SL**".
Symbol "✱" is shown.

Suppression of reheating by the boiler in conjunction with control units with KM BUS

- Function enabled:
 - The DHW cylinder is heated by the solar thermal system.
 - Connection of the KM BUS to terminals 11 and 12 in the solar control unit.
- In the boiler control unit, coding address "67" defaults a third set DHW temperature. (This value must be **below** the first set DHW temperature).
See the installation and service instructions of the boiler control unit.
- The DHW cylinder will only be heated by the boiler, if this set value cannot be achieved by the solar thermal system.

Note

In some boiler control units, the PCB must be replaced (see page 68).

System scheme (cont.)

"ANL" = 2

Dual-mode DHW heating with suppression of reheating by the boiler in conjunction with control units without KM BUS and/or control of the secondary pump of an external heat exchanger

Display

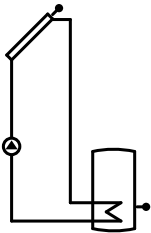

Suppression of reheating by the boiler in conjunction with control units without KM BUS

- Function enabled:
 - The DHW cylinder is heated by the solar thermal system.
 - A resistor simulates an actual DHW temperature that is 10 K higher (for connections, see the following table).
- The DHW cylinder will only be heated by the boiler, if the set DHW temperature cannot be achieved by the solar thermal system.

System with an external heat exchanger

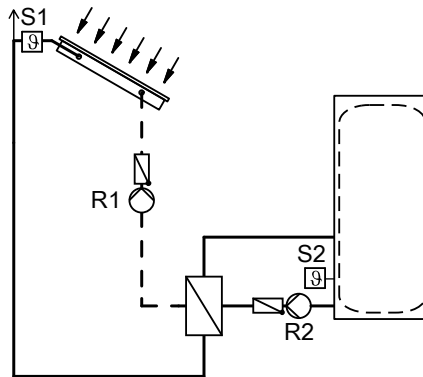

The secondary pump R2 is started in parallel with the solar circuit pump.

System scheme (cont.)

Cylinder temperature sensor as PTC

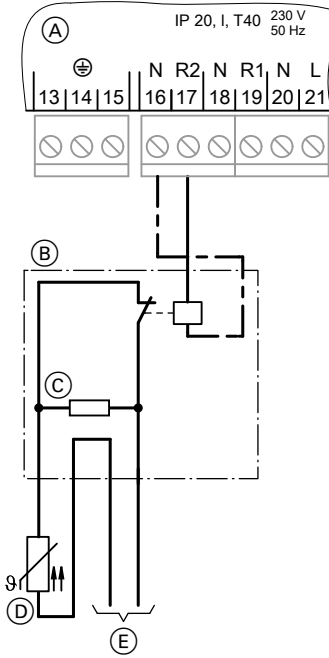

Cylinder temperature sensor as NTC

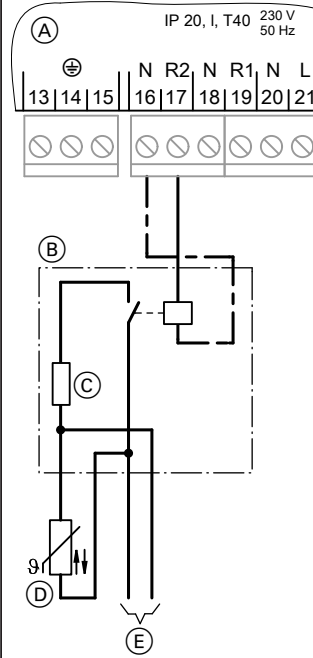

(C) Resistor 20 Ω, 0.25 W (on-site)

(C) Resistor 10 kΩ, 0.25 W (on-site)

(A) Solar control unit wiring chamber

(B) Contactor relay

(E) To the boiler control unit; connection for cylinder temperature sensor

(D) Cylinder temperature sensor of the boiler control unit

System scheme (cont.)

"ANL" = 3

Dual-mode DHW heating and thermostat function

Display

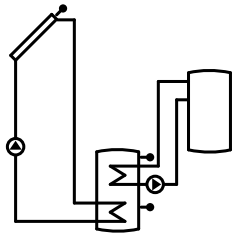

Thermostat function

Output R2 is used for this function.

Relay R2 switches subject to the temperature at S3 (see the following table).

Different effects can be achieved by determining the start and stop temperatures:

"NH E" < "NH A"

e.g. for reheating

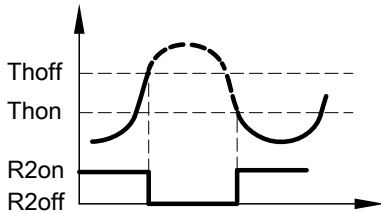

"NH E" > "NH A"

e.g. for utilising excess heat

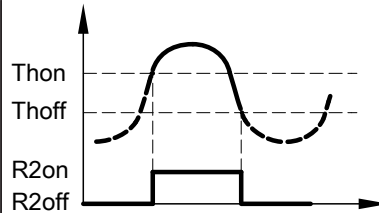

"ANL" = 4

Dual-mode DHW heating and auxiliary function

Display

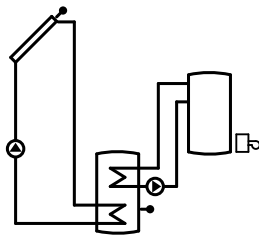

Auxiliary function for DHW heating

- Connection of the anti-stratification pump at R2.
- Signal for starting the anti-stratification pump R2 via the KM BUS of the boiler control unit. This also heats the lower area of the DHW cylinder to the required temperature.

Note

In some boiler control units, the PCB must be replaced (see page 68).

System scheme (cont.)

1. Connect the KM BUS at terminals 11 and 12 in the solar control unit.
2. Program the second set DHW temperature at the boiler control unit.



Installation and service instructions; boiler control unit

3. Adjust the fourth DHW phase at the boiler control unit.



Operating instructions, boiler control unit



Danger

DHW with temperatures in excess of 60 °C can cause scalding.

To limit the temperature to 60 °C, install mixing equipment, e.g. a thermostatically controlled mixing valve (accessory). Install a mixer tap as anti-scalding device at the draw-off point.

"ANL" = 5

Dual-mode DHW heating, thermostat function and auxiliary function

Display

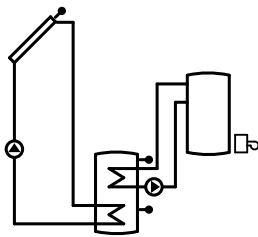

Output R2 enables the thermostat function (see page 56) and the auxiliary function (see page 56) to be achieved.

System scheme (cont.)

"ANL" = 6

Dual-mode DHW heating and maximum cylinder temperature control

Display

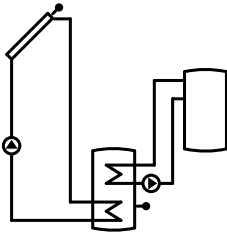

- When exceeding the set cylinder temperature "S SL" (see page 53) the anti-stratification pump R2 will start.
- Excess heat is transferred, e.g. to the pre-heating stage.

"ANL" = 7

Dual-mode DHW heating and anti-stratification

Display

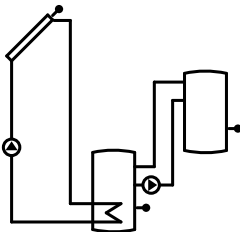

Determination of the temperature differential between collector temperature sensor S2 and cylinder temperature sensor S3.

- Anti-stratification pump R2 on:
Exceeding "DT 3E"
- Anti-stratification pump R2 off:
The actual temperature falls below the stop temperature differential "DT 3A"

"ANL" = 8

Dual-mode DHW heating, auxiliary function and anti-stratification with sensor S3 in DHW cylinder 2 (existing)

Display

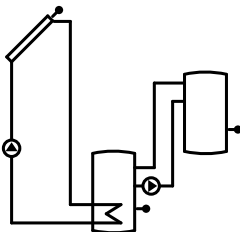

The anti-stratification pump R2 circulates the heating water to prevent stratification (see page 58) and implements the auxiliary function (see page 56).

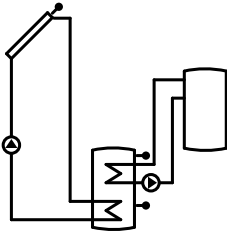
System scheme (cont.)**"ANL" = 9****Dual-mode DHW heating, auxiliary function and anti-stratification with sensor S3 in DHW cylinder 1 (retrofit)****Display**

The anti-stratification pump R2 circulates the heating water to prevent stratification (see page 58) and implements the auxiliary function (see page 56).

System scheme (cont.)

"ANL" = 10

Dual-mode DHW heating, heating of consumer 2 via the three-way diverter valve

Display

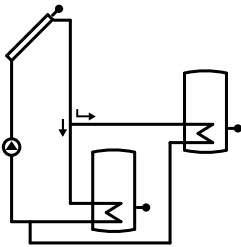

Temperature differential control

Determination of the temperature differential between collector temperature sensor S1 and cylinder temperature sensor S2.

- Solar circuit pump R1 on:
Exceeding **"DT 1E"**
Consumer 1 is being heated.
- Solar circuit pump R1 off:
The actual temperature falls below the stop temperature differential **"DT 1A"**

Determination of the temperature differential between collector temperature sensor S1 and cylinder temperature sensor S3.

- Solar circuit pump R1 and three-way diverter valve R2 on:
Exceeding **"DT 2E"**
Consumer 2 is being heated.
- Solar circuit pump R1 and three-way diverter valve R2 off:
The actual temperature falls below the stop temperature differential **"DT 2A"**

Cyclical heating

- If the DHW cylinder cannot be heated with priority (**"PRIO" 1**), the next consumer in line will be heated for an adjustable cycle time **"tUMW"**.
- After expiry of this time, the solar control unit checks the temperature rise at the collector during the cycle pause time **"tSP"**.
- As soon as the start conditions for the consumer with priority (**"PRIO" 1**) have been met, that consumer will be heated again. Otherwise, the consumer with lower ranking will continue to be heated.
- Once the consumer with priority has reached its set temperature **"S SL"**, **no** cyclical heating will be implemented.

System scheme (cont.)

Consumer 1

Parameters	Delivered condition	Setting range
DT 1E	8.0 K	1.5 – 20.0 K
DT 1A	4.0 K	1.0 – 19.5 K
S1 SL	60 °C	4 – 90 °C

Note

"DT 1E" can be set at least 0.5 K higher than "DT 1A".

"DT 1A" can be set at least 0.5 K lower than "DT 1E".

Consumer 2

Parameters	Delivered condition	Setting range
DT 2E	8.0 K	1.5 – 20.0 K
DT 2A	4.0 K	1.0 – 19.5 K
S2 SL	60 °C	4 – 90 °C

Note

"DT 2E" can be set at least 0.5 K higher than "DT 2A".

"DT 2A" can be set at least 0.5 K lower than "DT 2E".

Parameters	Delivered condition	Setting range
PRI0	1	0 – 2
tSP	2 min	1 – 30 min
tUMW	15	1 – 30 min

- 0 Priority consumer 1, no cyclical heating
- 1 Priority consumer 1, with cyclical heating
- 2 Priority consumer 2, with cyclical heating

Function description

Collector limit temperature

The solar circuit pump is switched OFF to protect the system components if the "NOT" temperature has been exceeded; the symbol "△" flashes.

Set value for "NOT" (see page 45).

Setting parameters	Delivered condition	Setting range
NOT	130 °C	110 – 200 °C

Note

This function is disabled at setting 200 °C.

Collector cooling function

The solar circuit pump will be switched off when the set cylinder temperature "S SL" is reached.

If the collector temperature rises to the set maximum collector temperature "KMX", the pump will be switched ON long enough to enable this temperature to fall 5 K lower (the symbol "✱" flashes). The cylinder temperature can then rise again, but only up to 90 °C; at that point, the solar circuit pump is switched off (the symbol "△" flashes).

1. Set "OKX" to "ON" (see page 45).
2. Select the "KMX" value.

Setting parameters	Delivered condition	Setting range
KMX	110 °C	90 – 190 °C

Minimum collector temperature limit

Minimum starting temperature "KMN" that must be exceeded before the solar circuit pump can start. This prevents the pump starting too frequently (cycling).

The pump is switched OFF, if the actual temperature falls 5 K below this temperature; symbol "✱" flashes.

1. Set "OKN" to "ON" (see page 45).
2. Select the "KMN" value.

Minimum collector temperature limit (cont.)

Setting parameters	Delivered condition	Setting range
KMN	10 °C	10 – 90 °C

Frost protection function

Enable this function only when using water as heat transfer medium. The solar circuit pump will be switched ON to avoid collector damage, if the collector temperature falls below the "KFR" value.

The symbol "❄" is displayed if this function is enabled and flashes if the solar circuit pump is running.

1. Set "OKF" to "ON" (see page 45).
2. Select the "KFR" value.

Setting parameters	Delivered condition	Setting range
KFR	4 °C	-10 – +10 °C

Reverse cooling function

Enable only in systems with flat-plate collectors. The "ORUE" function only makes sense if the collector cooling function has been enabled (see page 62). The collector cooling function enables the heating of the DHW cylinder to a higher temperature than "S SL" (see page 53).

In the evening, the pump will continue to run (symbol "❄" flashes) until the DHW cylinder has been cooled down via the collector and the pipework to the set cylinder temperature "S SL".

Set "ORUE" to "ON" (see page 45).

Interval function

Activate the interval function in systems where the collector temperature sensor is not in an ideal location to prevent a time delay in capturing the collector temperature.

For this, the solar circuit pump is started for 30 s when the collector temperature rises by 2 K.

Set "ORK" to "ON" (see page 45).

Function description

Heat statement

The heat statement is calculated from the temperature differential between the collector and cylinder temperature as well as the selected throughput (see service instructions "Vitosol").

1. Set "**OWMZ**" to "**ON**" (see page 45).
2. Check the throughput at the flow meter of the Solar-Divicon at 100 % speed and set that value as "**VMAX**".

3. Adjusting the frost protection of the heat transfer medium "**MEDT**".
4. If necessary, adjust the mixing ratio of the heat transfer medium "**MED %**".

MEDT setting	Heat transfer medium
0	Water
1	Propylene glycol
2	Ethylene glycol
3	Viessmann heat transfer medium

Setting parameters	Delivered condition	Setting range
VMAX	5.0 l/min	0.1 – 20 l/min
MEDT	3	0 – 3
MED %	40 %	20 – 70 %

Speed control

Speed control is disabled at the factory ("**RPM**" set to 0, see page 45). It can only be enabled for relay output R1 (solar circuit pump).

The solar circuit pump should not have its own speed control. Set multi-stage pumps to the required stage.

Note

When using pumps with their own variable speed control, set "**RPM**" to 0.

The solar circuit pump will be switched ON, if "**DT E**" has been exceeded. If the temperature differential rises to "**DT S**" (differential temperature for the start of the speed control), then the speed is increased by 10% with every rise by the value selected in "**ANS**" (rise).

Speed control (cont.)

Setting parameters	Delivered condition	Setting range
n1MN	30 %	30 – 100 %
DT S	10 K	0.5 – 30 K
ANS	2 K	1 – 20 K

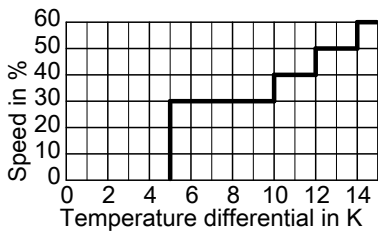
Example

DTE =8 K
 DT S =10 K
 ANS =2 K

Enabling speed control

Set the required value for **"RPM"** (see page 45).

- 1 Standard solar circuit pumps (with integral auxiliary capacitor)
- 2 WILO pump with PWM input
- 3 GRUNDFOS pump with PWM input

Parts list

Parts list

When ordering spare parts

Quote the part and serial no. (see type plate) and the position no. of the required part (as per this parts list).

Obtain standard parts from your local supplier.

- 030 Strain relief pack, capacitor and fuse
- 040 Fuse, 4 A (slow)
- 050 Installation and service instructions
- 060 Operating instructions

Parts

- 010 Collector temperature sensor
- 020 Cylinder temperature sensor

Specification

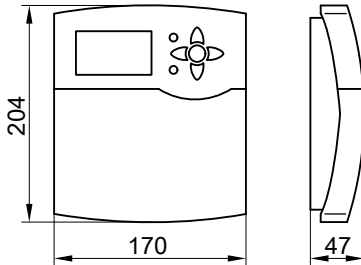

Rated voltage	230 V~
Rated frequency	50 Hz
Rated current	4 A~
Power consumption	2 W (in standby mode 0.7 W)
Protection class	II
Protection	IP 20 D to EN 60529, ensure through design/installation
Function	Type 1 B to EN 60730-1
Permiss. ambient temperature	0 to +40 °C
■ during operation	Installation in living spaces or boiler rooms (standard ambient conditions)
■ during storage and transport	-20 to +65 °C
Rated breaking capacity of the relay outputs at 230 V~:	
■ R1	0.8 A~
■ R2	4 (2) A ~

Appendix

Replace the PCB in the stated boiler control units in conjunction with the following functions:

- Suppression of reheating by the boiler
- Auxiliary function for DHW heating, achieved by the solar control unit

Control unit	Electronics PCB
Vitotronic 200, type KW1, part no. 7450 351, 7450 740	Part no. 7828 192
Vitotronic 200, type KW2, part no. 7450 352, 7450 750	
Vitotronic 300, type KW3, part no. 7450 353, 7450 760	
Vitotronic 200, type GW1, part no. 7143 006	part no. 7828 193
Vitotronic 300, type GW2, Part no. 7143 156	
Vitotronic 333, type MW1, Part no. 7143 421	Part no. 7824 030

Declaration of conformity

We, Viessmann Werke GmbH & Co KG, D-35107 Allendorf, confirm as sole responsible body that the product **Vitosolic 100** complies with the following standards:

EN 55 014-1
EN 60 730

This product is designated **CE** in accordance with the following Directives:

2004/108/EC
2006/95/EC

Allendorf, 1 April 2009

Viessmann Werke GmbH&Co KG



pp. Manfred Sommer

Keyword index

A

Anti-scalding protection.....6, 57
 Anti-stratification.....58
 Applicability.....72
 Automatic mode.....44, 45
 Auxiliary function for DHW heating....56

C

Changing settings.....45
 Changing the fuse.....48
 Changing values.....45
 Checking sensors.....47
 Collector cooling function.....62
 Collector limit temperature.....62
 Collector temperature sensor.....40
 Commissioning.....44
 Cyclical heating.....60
 Cylinder temperature limit.....53
 Cylinder temperature sensor.....41

D

Declaration of conformity.....69

E

External heat exchanger.....54

F

Fault messages.....47
 Fitting the solar control unit.....35
 Frost protection function.....63

H

Hardware version.....51
 Heat statement.....64
 High limit safety cut-out.....39

I

Interval function.....63

M

Manual mode.....45
 Manual operation.....45
 Maximum collector temperature limit. 62

Maximum cylinder temperature

control.....58

Minimum collector temperature limit. 62

N

Navigation through the menu.....44

O

Operating steps.....44

Overview of electrical connections....36

P

Parts list.....66

Power supply.....42

Pump at R2.....38

Pumps.....36

R

Relay test.....45

Restoring the delivered condition.....45

Reverse cooling function.....63

S

Scanning temperatures.....46

Selecting the system scheme.....44

Setting system parameters.....45

Software version of the solar control

unit.....51

Solar circuit pump.....36

Spare fuse.....48

Speed control.....64

Starting the solar control unit.....44

Suppressing reheating

■ Control units with KM BUS.....53

■ Control units without KM BUS.....54

Switching the power ON.....44

T

Temperature differential control...53, 60

Temperature sensor.....41

Thermostat function.....56

Keyword index (cont.)

V
Valve at R2.....38